

324086 ✓ ACTIVE



PIDG

TE Internal #: 324086

Ring Terminals & Spade Terminals, Ring Tongue, 16 – 14 AWG

Wire Size, 1.25 – 2 mm² Wire Size, 2050 – 5180 CMA Wire Size, Stud

Size #12, PIDG

[View on TE.com >](#)

Terminals & Splices > Ring Terminals & Spade Terminals > PIDG RING TONGUE TERMINALS

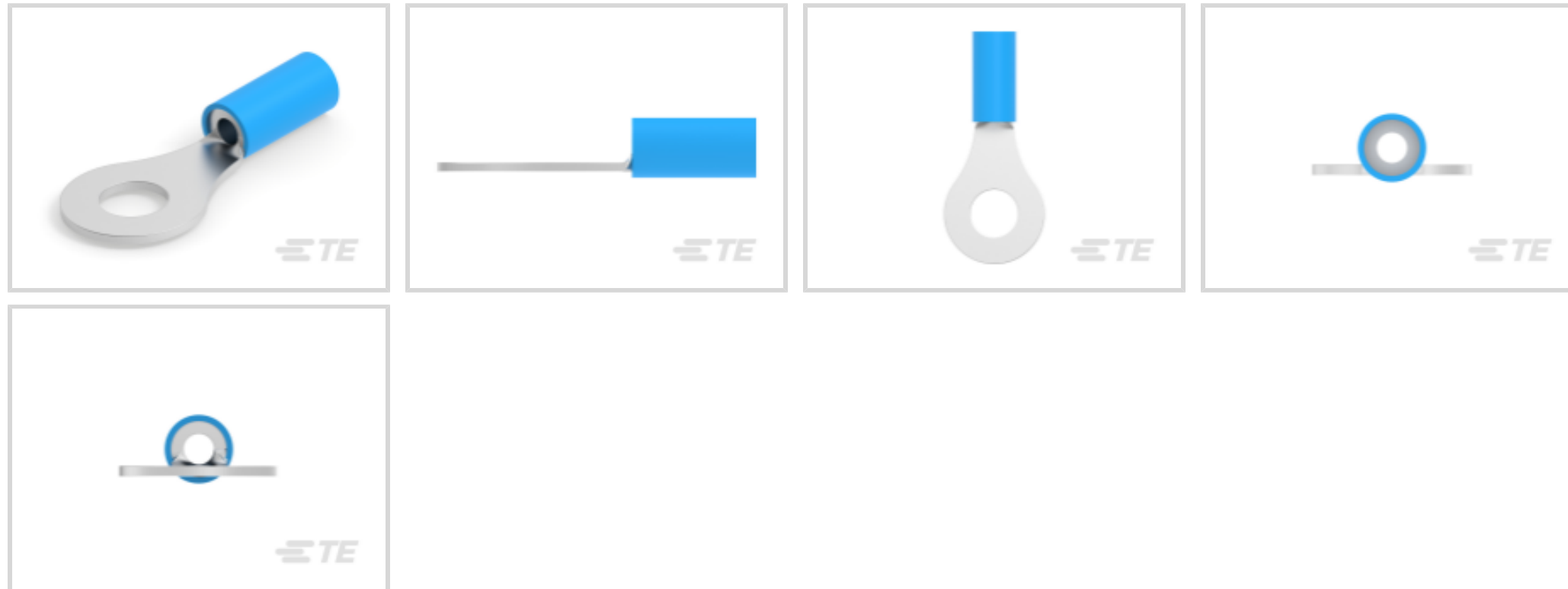

Ring & Spade Terminal Type: Ring Tongue

Wire Size: 2050 – 5180 CMA

Stud Size: #12

[All PIDG RING TONGUE TERMINALS \(421\)](#)

Features

Product Type Features

| | |
|--|--------------------|
| Shape Description | RING-041 |
| Stud Size | #12 |
| Sealable | No |
| Wire Insulation Support Retention Type | Insulation Support |

Configuration Features

| | |
|-----------------|-------|
| Number of Holes | 1 |
| Terminal Angle | 180 ° |

Electrical Characteristics

| | |
|---------------|-------|
| Voltage (Max) | 300 V |
|---------------|-------|

Body Features

| | |
|------------------|---------|
| Inspection Slot | No |
| Weight per Piece | 1.448 g |

Contact Features

| | |
|--|--|
| | |
|--|--|

| | |
|----------------------------|-------------|
| Ring & Spade Terminal Type | Ring Tongue |
| Barrel Type | Closed |
| Terminal Orientation | Straight |
| Terminal Plating Material | Tin |

Mechanical Attachment

| | |
|-------------------------|------|
| Wire Insulation Support | With |
|-------------------------|------|

Dimensions

| | |
|--|-------------------------------|
| Wire Size | 2050 – 5180 CMA |
| Stud Diameter | 5.66 mm[.223 in] |
| Tongue Thickness | .79 mm[.031 in] |
| Overall Product Length | 27.38 mm[1.078 in] |
| Accepts Wire Insulation Diameter (Max) | 4.32 mm[.17 in] |
| Accepts Wire Insulation Diameter Range | 2.92 – 4.31 mm[.115 – .17 in] |

Usage Conditions

| | |
|-----------------------------|---------------------|
| Insulation Option | Partially Insulated |
| Operating Temperature Range | 105 °C[221 °F] |

Operation/Application

| | |
|---------------------------------------|--------|
| Compatible With Wire Base Material | Copper |
| Compatible With Wire Plating Material | Tin |
| Heavy Duty | No |

Industry Standards

| | |
|----------------------|----|
| Government Qualified | No |
|----------------------|----|

Packaging Features

| | |
|--------------------|-------------|
| Packaging Quantity | 1000 |
| Packaging Method | Loose Piece |

Product Compliance

[For compliance documentation, visit the product page on TE.com>](#)

| | |
|---|---|
| EU RoHS Directive 2011/65/EU | Compliant |
| EU ELV Directive 2000/53/EC | Compliant |
| China RoHS 2 Directive MIIT Order No 32, 2016 | No Restricted Materials Above Threshold |
| EU REACH Regulation (EC) No. 1907/2006 | |



Current ECHA Candidate List: JUNE 2022 (224)

Candidate List Declared Against: JUNE 2022 (224)

Does not contain REACH SVHC









| | |
|-----------------|---|
| Halogen Content | Low Halogen - Br, Cl, F, I < 900 ppm per homogenous material. Also BFR/CFR/PVC Free |
|-----------------|---|

| | |
|---------------------------|--|
| Solder Process Capability | Not applicable for solder process capability |
|---------------------------|--|

Product Compliance Disclaimer

This information is provided based on reasonable inquiry of our suppliers and represents our current actual knowledge based on the information they provided. This information is subject to change. The part numbers that TE has identified as EU RoHS compliant have a maximum concentration of 0.1% by weight in homogenous materials for lead, hexavalent chromium, mercury, PBB, PBDE, DBP, BBP, DEHP, DIBP, and 0.01% for cadmium, or qualify for an exemption to these limits as defined in the Annexes of Directive 2011/65/EU (RoHS2). Finished electrical and electronic equipment products will be CE marked as required by Directive 2011/65/EU. Components may not be CE marked. Additionally, the part numbers that TE has identified as EU ELV compliant have a maximum concentration of 0.1% by weight in homogenous materials for lead, hexavalent chromium, and mercury, and 0.01% for cadmium, or qualify for an exemption to these limits as defined in the Annexes of Directive 2000/53/EC (ELV). Regarding the REACH Regulation, the information TE provides on SVHC in articles for this part number is based on the latest European Chemicals Agency (ECHA) 'Guidance on requirements for substances in articles' posted at this URL: <https://echa.europa.eu/guidance-documents/guidance-on-reach>

Compatible Parts

| | | | |
|--|---|---|--|
|  <p>TE Part # 59824-1 TETRA-CRIMP PIDG PG FASTON 22-10 ASSY</p> |  <p>TE Part # 58433-3 PRO CR ASSY, RBY IS9252</p> |  <p>TE Part # 59250 T-HEAD PIDG 26-14 ASSY</p> |  <p>TE Part # 47387 DAHT PG PIDG 20-14 ASSY</p> |
|  <p>TE Part # 58423-1 DIE, RBY IS9252</p> |  <p>TE Part # 47387-7 DAHT PG PIDG 16-12 ASSY</p> |  <p>TE Part # 525691 DAHT PG PIDG 16-14 ASSY</p> |  <p>TE Part # 539691-2 ERGO DIE R.B.Y</p> |

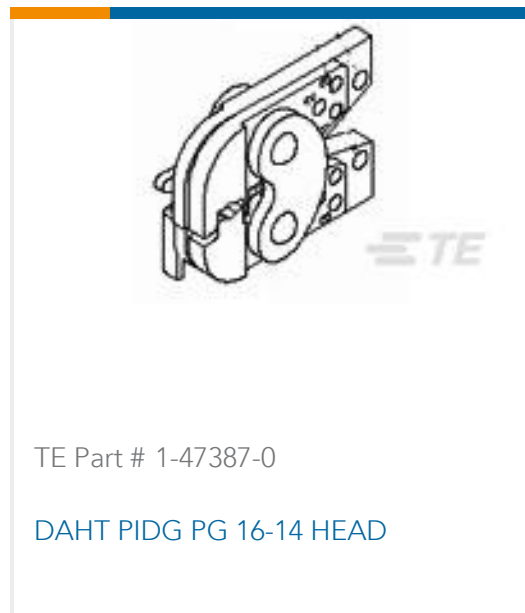

Also in the Series | PIDG

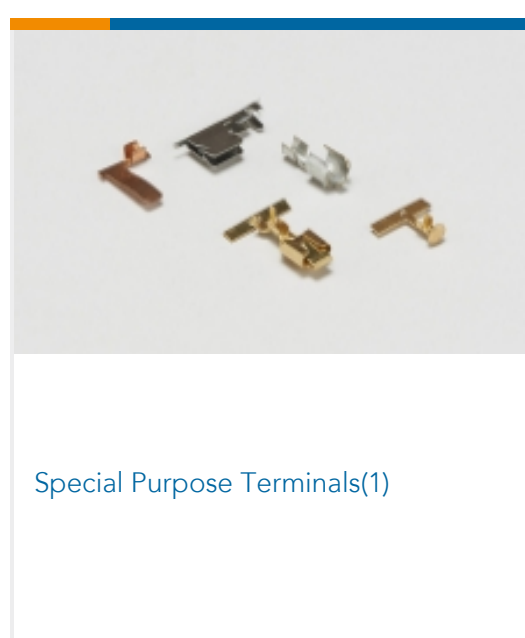
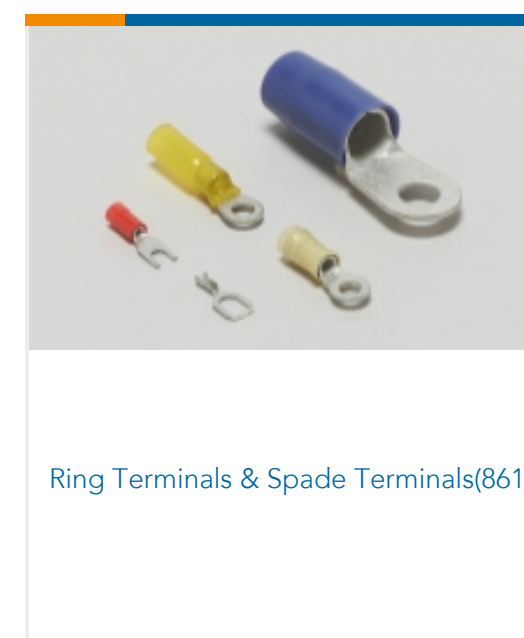
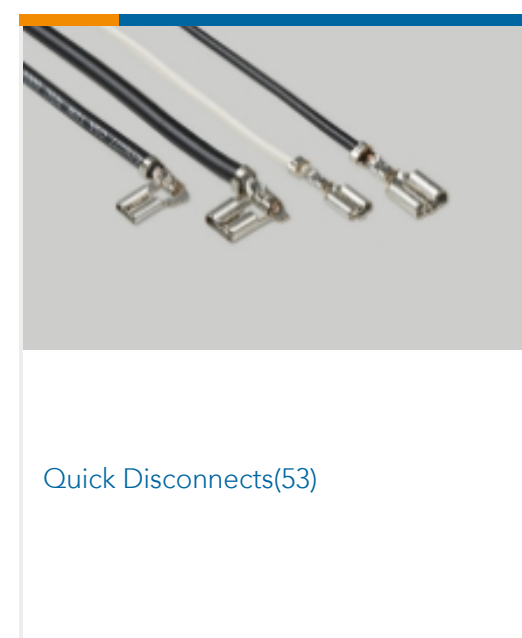
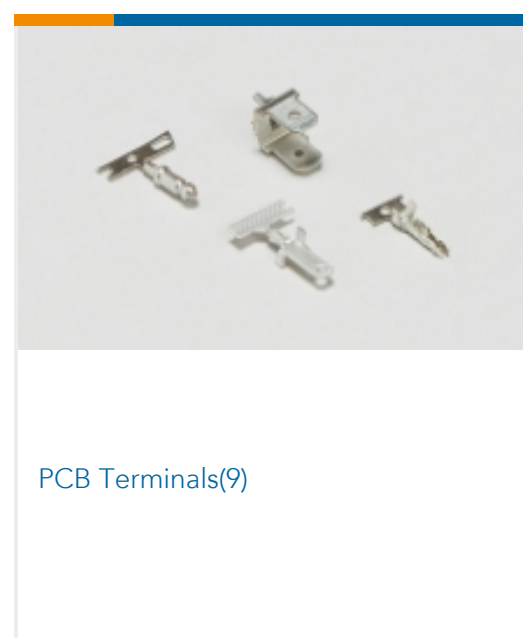
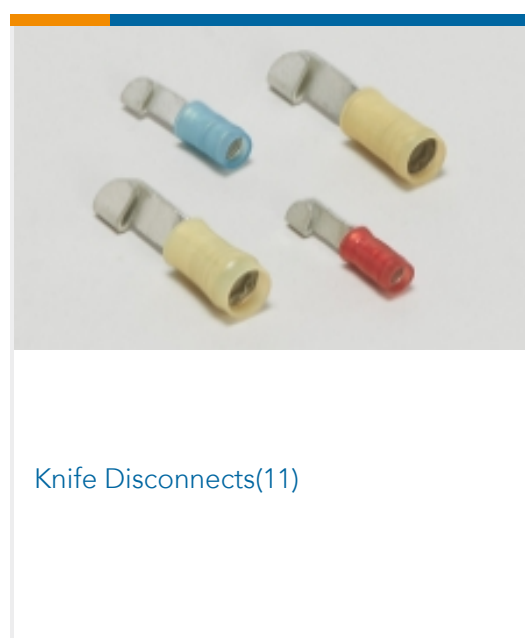
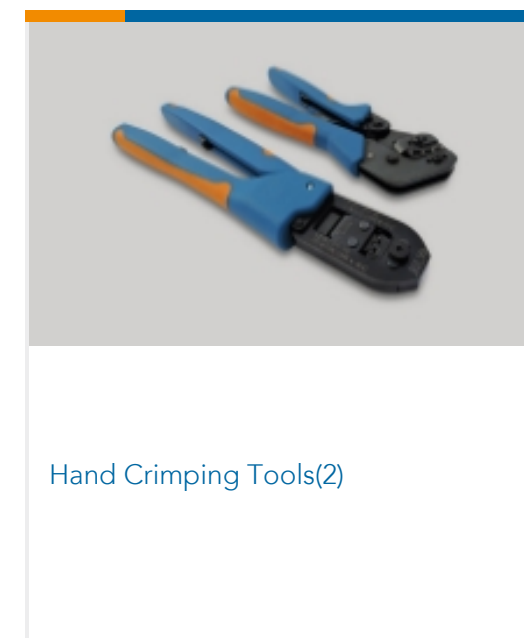
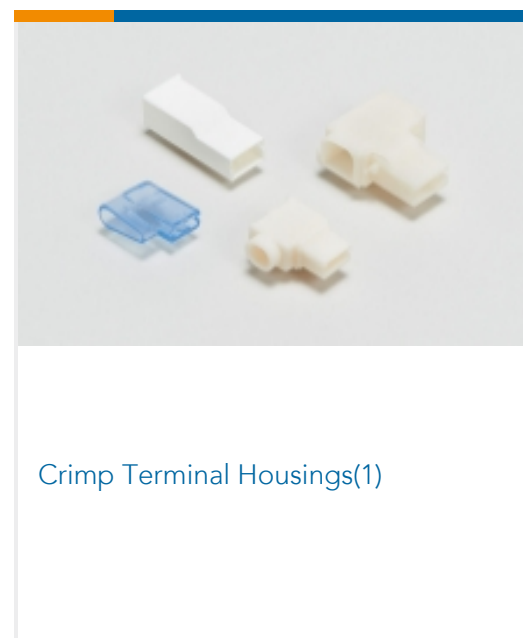
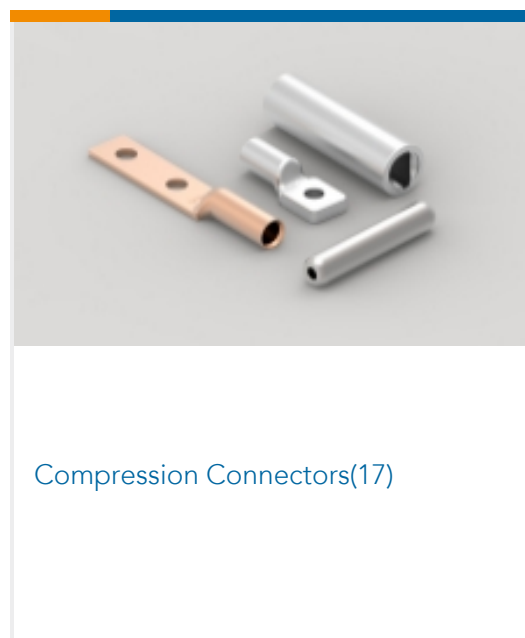

Documents



Product Drawings

[TERMINAL,PIDG R 16-14 12](#)

English

CAD Files

[3D PDF](#)

3D

Customer View Model

[ENG_CVM_CVM_324086_E.2d_dxf.zip](#)

English

Customer View Model

[ENG_CVM_CVM_324086_E.3d_igs.zip](#)

English

Customer View Model

[ENG_CVM_CVM_324086_E.3d_stp.zip](#)

English

By downloading the CAD file I accept and agree to the [Terms and Conditions](#) of use.

Product Specifications

[Application Specification](#)

English

Product Environmental Compliance

[MD_324086_05052014651_dmtec](#)

English

[MD_324086_05052014651_dmtec](#)

English

Agency Approvals

[UL Report](#)

English